

Quick Refill Guide

Step 1 - Turn off the water using the shut off valves, both valves must be closed

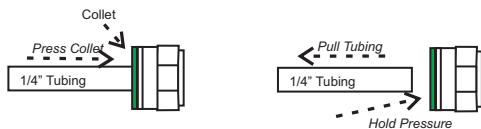

Step 2 - Disconnect tubing from both sides



Step 3 - Unscrew cap & pour out water or open drain plug (EZ005-FX & larger)

The system will be full of fresh water when fertilizer is gone

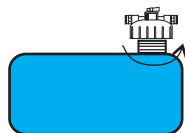

Some products may leave a slight residual. This may be left in the tank or flushed out

Step 4 - Fill tank with product

Reference Fill Section for Maximum Capacities

Results depend on product quality, use **MAXX-PRODUCTS** for best performance

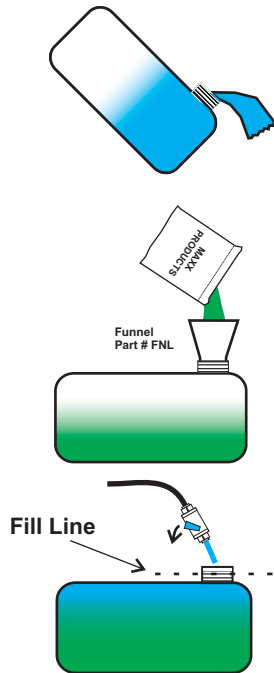

Step 5 - Fill tank with water by opening shut off valve or hose until full

DO NOT LEAVE AIR IN THE TANK

Step 6 - Screw on tank cap, replace washers, attach valves & turn on both shut off valves

*Check to make sure o-ring is in place prior to screwing the cap back on.

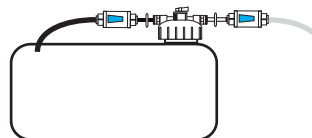

INJECTION SYSTEMS

**INSTALLATION AND OPERATING GUIDE
MAINLINE SYSTEMS**



**For an overview of the EZ-FLO System
Installation & Operation:**

www.ezfloinjection.com/videos/

*** IMPORTANT ***
**READ INSTRUCTIONS BEFORE INSTALLING THE SYSTEM
TO INSURE PROPER INSTALLATION**

**EZ-FLO Coupling Ball Valve Required for Installation
Sold Separately**

- Do not connect to an irrigation system that is not protected by an approved back flow prevention device
- Do not install if pressure exceeds 80 PSI
- Use only with non-hazardous products
- Minimize exposure to direct sunlight to maximize service life
- Protect against freezing to avoid tank fracture

TANK ASSEMBLY & PARTS LIST

Replacement parts available through EZ-FLO distributors

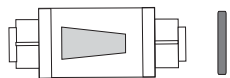
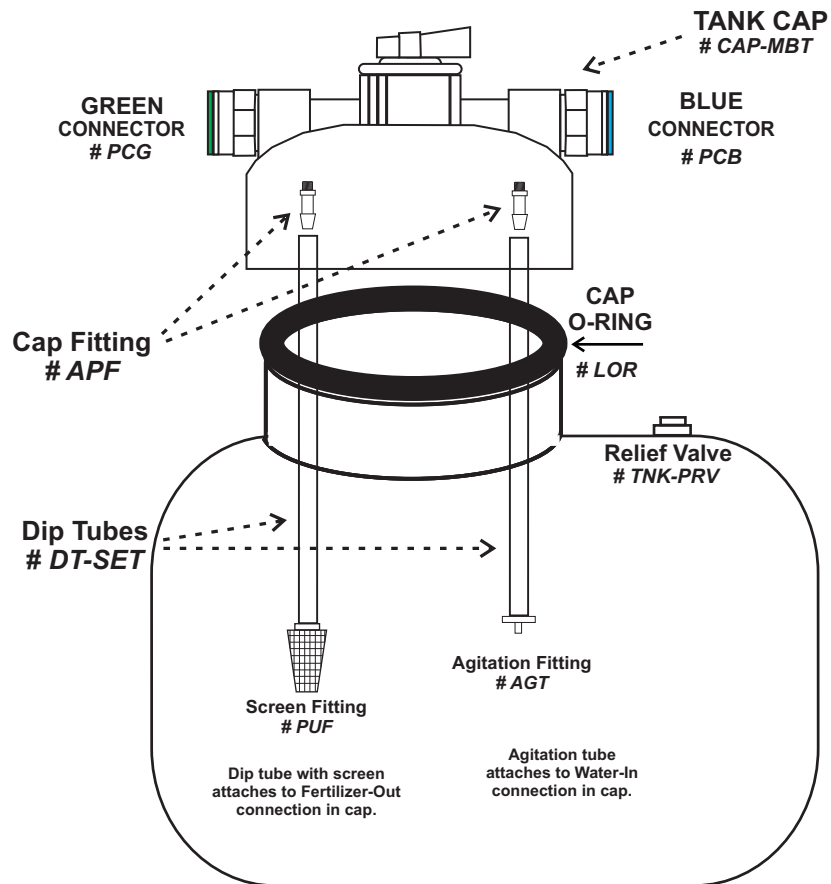

2 - Shut Off Valves
Part # SOV with 2 washers



3 - Tubing Clamps
Part # RTC (1 Extra)

5- Feet 1/4" Black Tubing
Part # BT5

5- Feet 1/4" Clear Tubing
Part # CT5

For EZ-FLO Warranty information visit our website at
www.ezfloinjection.com

Frequently Asked Questions

Will I over fertilize?

No. When the unit is set on the maintenance (slow) setting it feeds in small amounts. It applies less fertilizer over the same period of time than applying in large amounts once every 6 weeks.

Will the system clog drip irrigation?

No. The EZ-FLO and Maxx-Products can help clean drip systems and make them work effectively.

If product is mixed with water, will it dilute?

This depends on the product but the patented flow process prevents dilution. EZ-FLO dispenses products slowly over a long period of time so if dilution occurs, it will not effect the products performance.

Will the fertilizer stain?

EZ-FLO MAXX-PRODUCTS and most fertilizers will not stain when dispensed through the EZ-FLO system. Check with manufacturers of other products to confirm they will not stain prior to use.

How do I winterize the system?

Simply close the shut off valves, disconnect it from the irrigation system and drain the tank.

The system did not inject any fertilizer

Refer to the "Connector Calibration" and set the CBV to a further closed position.

The system is emptying too fast

Confirm you used the correct cap setting and check the "Connector Calibration" page and adjust the CBV to a more open position.

My system is always full of water, is it working?

Yes! This is part of our patent and you can review the videos on our website to see how it works.

All EZ-FLO systems have been specifically designed and engineered to be installed by a professional irrigation or landscape contractor but may be installed by the end user without voiding the warranty. Improper installation or use could cause risk of water contamination due to back flow or tank rupture. Failure to follow all safety instructions and warnings could result in serious bodily injury. Improper installation or use of the system voids all warranties.

Frequently Asked Questions

How much product to put into the tank?

Refer to the product label and tank capacity. The system feeds very slowly and it is difficult to over fertilize when using the system properly. Typical rates are 1 gallon of liquid per 10,000 sqft of landscape per month and 10 lbs of dry powder fertilizer per 10,000 sqft of landscape per month.

What fertilizer can I use?

Almost any liquid or water soluble powder product. All Maxx-Products work with the system and are specifically engineered for fertigation. Do not use dry broadcast fertilizers, they are not compatible and may cause damage to the EZ-FLO or irrigation system.

Can I use weed killer/ herbicide in the system?

Typically no, hazardous products are not recommended for use in the EZ-FLO system and the application of herbicide should be tightly controlled.

What cap setting should I use?

Slow and #1 are the most common cap settings and generally the safest unless you are familiar with the fertilizer product and injection system. The closer to fast, the faster the system will run out of product.

How often do I need to refill?

This will vary on landscape size and watering schedule. If you follow the EZ-FLO sizing and use recommendations, you will typically last 4 to 6 weeks. If your landscape is smaller it will last longer. If the landscape is larger or you water heavily, the system will empty faster.

How do I know when to refill?

The system can be checked for color by viewing the clear output tubing during irrigation operation. If the fertilizer color is gone, you need to refill the system. **Alternatively, you may let the system run without fertilizer (just water) and refill based on a set schedule.**

How do I know it is working?

When the irrigation system is running and the system is full of fertilizer, watch the clear output tube for color. You may adjust the cap from slow to fast to see the color change. You can use blue or green food dye to add color to the fertilizer.

CAP Tubing Fittings: Insert & Release

Top View

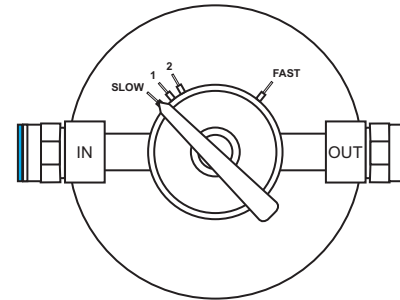

Side View

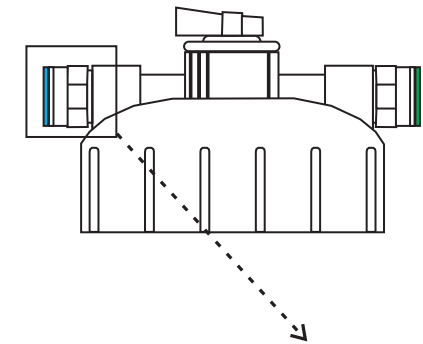

The EZ-FLO system uses push connect fittings to connect the clear and black 1/4" tubing to the cap.

To Insert:

Step 1. Insert the end of the tubing into the appropriate side (Clear to Green/Out and Black to Blue/In) by pressing into the hole/Collet. Press gently until the tubing stops.

Step 2. Gently tug the tubing to insure it is locked into place.

To Remove:

Step 1. Shut off pressure to the system.

Step 2. Apply gentle pressure to the Green or Blue Collet with your fingers.

Step 3. While holding pressure, gently pull the tubing away from the fitting to release.

Note: Make sure to direct the fitting away from your face and body. A small amount of residual pressure may be in the tank and cause a momentary release of fluid.

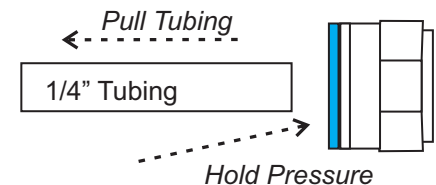
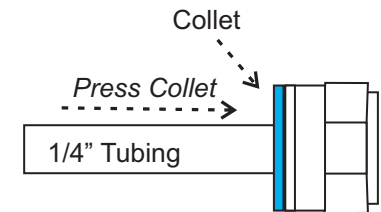
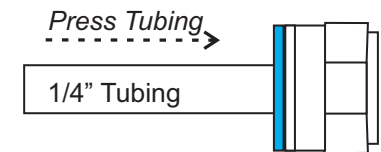
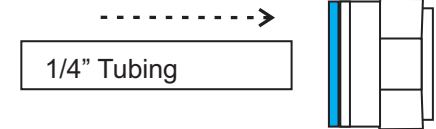

System Installation

Typical installation

The system is normally installed in a valve box, connected to the main line of the irrigation system after the back flow preventer and before the sprinkler valves. One unit will feed both drip and sprinkler zones without changing any connections or nozzles. It will feed both the front and back yard landscapes.

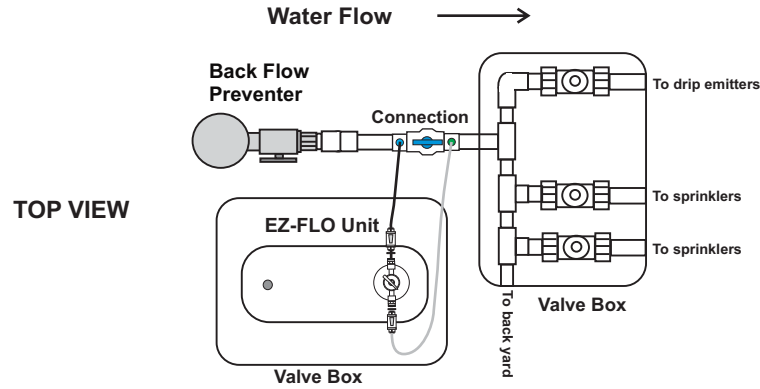

Step 1 - Locate the installation point.

Connection must be made after an approved back flow prevention device. The connection can be made either **vertically or horizontally** in the irrigation main line. The connection may be installed above or below the tank without issue.

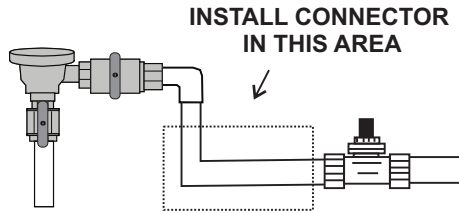

Step 2 - Shut off water and relieve pressure

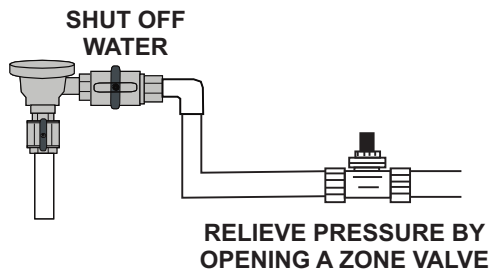

Set Flow Adjustment

Step 10 - Set the flow rate by turning the adjustment knob to the proper setting.

Slow Setting - is used for normal and most common setting in regions with high watering requirements such as hot dry climates or sandy soils.

#1 Setting - is used for normal maintenance in regions with more moderate climates and moderate watering schedules where soils have good moisture retention.

#2 Setting - is used to encourage fast growth or to quickly improve the condition of a landscape in poor condition. The unit will empty more quickly and can be refilled more often.

Fast Setting - is used to for periodic fertilization. The unit will empty more quickly and can be refilled more often.

Setting	*Ratio	OZ. of fertilizer per gal. of water	Based on Watering Frequency*
Slow	15000:1	.008 (1/20 tsp)	4+ days per week
1	8000:1	.017 (1/10 tsp)	3 days per week
2	2000:1	.064 (2/5 tsp)	2 days per week
Fast	400:1	.320 (2 tsp)	1 day per week

PROPORTIONING CAP

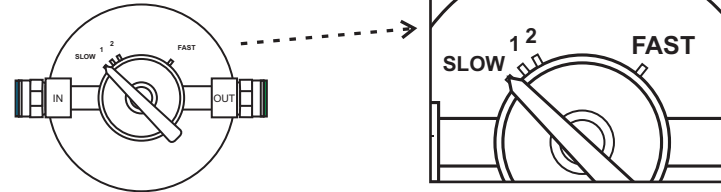

*Ratio refers to the amount of water mixed with the fertilizer. For example, a 400:1 ratio means 400 gallons of water will be mixed with 1 gallon of fertilizer. The adjustment knob can be set in between settings if desired. **These ratios are approximate because feed rates can vary by the type of product being distributed. Ratios are provide as a general guideline only.** The watering frequency guideline is general and for convenience only. Additional caution and care should be taken when using a feed setting faster than #1.

Gallons of Water Until Empty

The following table shows the approximate gallons of water required to distribute the fertilizer from the EZ-FLO system at the various flow settings.

Model	EZ001-CX	EZ003-CX	EZ005-FX	EZ010-FX
Slow	22,500	37,500	67,500	127,500
# 1	12,000	20,000	36,000	68,000
# 2	3,000	5,000	9,000	17,500
Fast	600	1,000	1,800	3,400

More detailed application instructions are available on our website:
www.ezfloinjection.com

Connector Calibration - Coupling Ball Valve

The CBV connection must be calibrated to the flow rate of your irrigation system. If the irrigation system is higher flow, primarily composed of spray heads or larger drip irrigation zones, adjustment to the CBV may not be required.

The EZ-FLO system must be full of fertilizer which provides a color that can be used to indicate flow through the clear line. If your fertilizer is not colored, add blue or green dye to the tank.

Start by setting the proportioning cap adjustment setting to the fast position and the CBV in full open position.

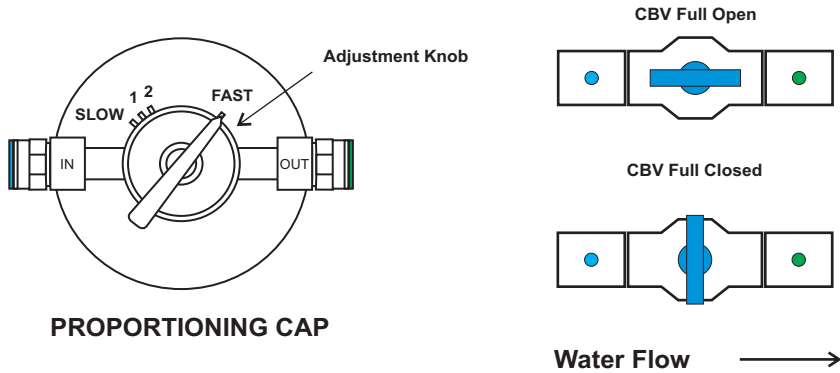

Step 9 - Turn on a sprinkler or drip zone with the closest to average gallons per minute flow rate and watch the clear fertilizer-out tubing for color

If color is steadily flowing through the clear output tube, the CBV does not require adjustment. **Please note the color in the tube will be lighter than the color in the tank due to the mixing**

If color is not flowing, slowly turn the CBV to the closed position in small increments, stopping once color begins to flow.

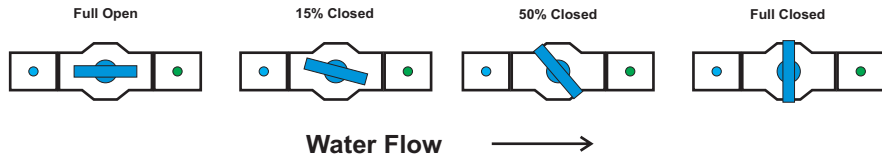

Once color is visible, you no longer have to adjust the CBV connection. You may leave it in position permanently. **Full closed is not common and may indicate improper installation or filling of the system.**

Set the Proportioning Cap feed rate to the desired level. **Please note, color will be lighter on the slower feed rate settings.**

Adjusting the ball valve will not affect the performance of the irrigation system. The valve closure is only necessary when the irrigation system is not operating at full capacity. Water is diverted through the EZ-FLO system as a bypass and reintroduced downstream of the valve eliminating the pressure and flow loss.

Main Line Connection

Step 3 - Cut out a section of pipe slightly larger than the cut out length of the coupling.

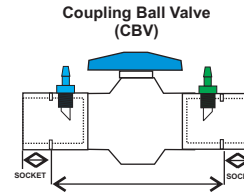

GLUE IN COUPLING WITH FLOW ARROW POINTING IN THE DIRECTION OF THE WATER FLOW

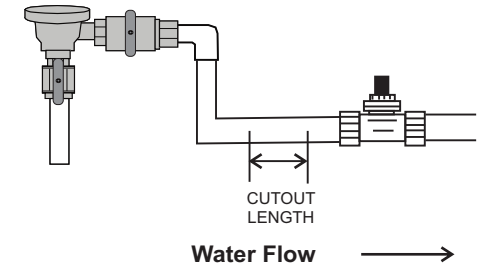

Step 4 - Glue the coupling into the line.

CBV-100 ONLY
USE INCLUDED REDUCING BUSHINGS FOR 3/4" PVC INSTALLATION

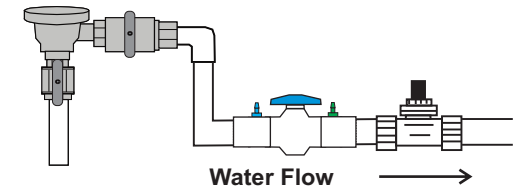

Step 5 - Attach tubing to the coupling.

ATTACH BLACK TUBING TO BLUE FITTING, CLEAR TUBING TO GREEN FITTING AND SECURE WITH TUBING CLAMPS

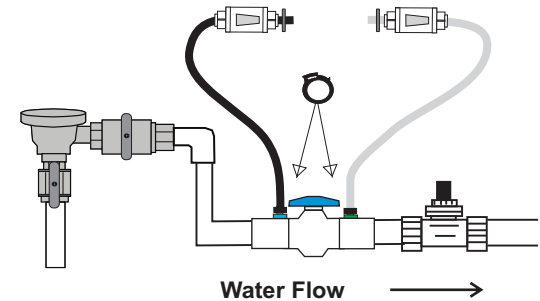

*Instructions for calibrating the CBV connection is on page 8.

Fill Tank with Product

Step 6 - The EZ-FLO system can be filled with any liquid or water soluble product. EZ-FLO MAXX-PRODUCTS are specifically designed for use with fertigation and all irrigation systems.

Fill the tank based on the product's coverage recommendations.

Typical Fertilizer Coverage Rates:

Liquid-	1 Gallon per 10,000 sqft every 4 to 6 weeks
Powder-	1 Pound per 1,000 sqft every 4 to 6 weeks

Pour fertilizer directly into tank and then top off with water until all air is gone from the tank. If your fertilizer is not colored, add blue or green dye.

Model	Tank Size	Maximum Capacity
EZ001-CX	1.5 Gallon	10 lbs dry or 1.5 gal. liquid
EZ003-CX	2.5 Gallon	15 lbs dry or 2.5 gal liquid
EZ005-FX	4.5 Gallon	25 lbs dry or 4.5 gal liquid
EZ010-FX	8.5 Gallon	50 lbs dry or 8.5 gal liquid

* ALL TANK CAPACITIES ARE APPROXIMATE *

Fill tank with product

Follow all product label precautions. Multiple products can be combined and applied all at one time. Base how much to put in the tank by each product's coverage recommendations.

DO NOT LEAVE AIR IN THE TANK

Air will fracture the tank and is not covered By the warranty

Fill tank with water from shut off valve or hose until full

Step 7 - Screw on tank cap

*Check to make sure o-ring is in place under the cap prior to screwing the cap back on.

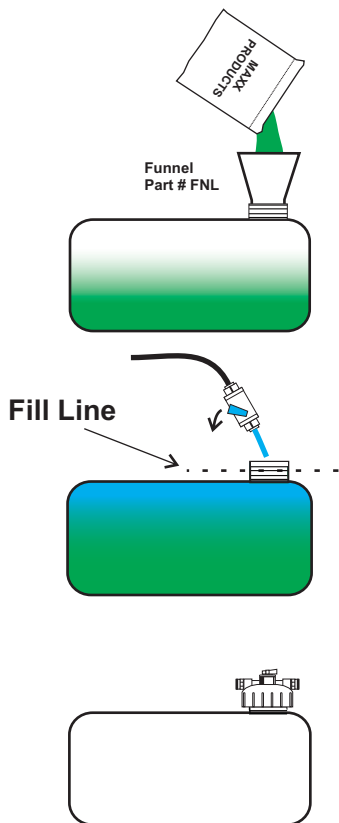

Connect Cap to Irrigation System

Step 8

Turn shut off valves to the off position (shown).

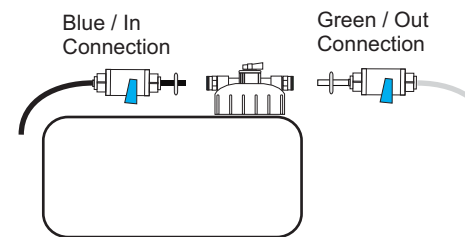

Turn water on at back flow preventer.

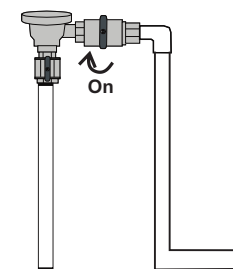

Connect blue side of connector to Water In connection by pressing the black tubing into the blue side of the cap.

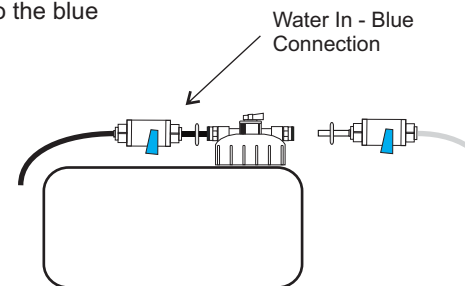

Bleed air from tank by slightly opening the shut off valve on the black line until water streams through the fertilizer out / green side, then close.

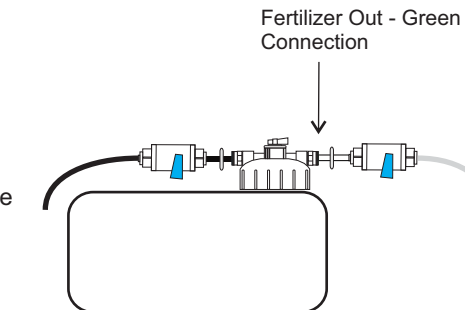

Connect green side of the connector to the green Fertilizer Out connection on cap by pressing the clear tubing into the green side of the cap.

Open both shut off valves.