

Fertilizing Systems

Fertilize Responsibly™

INSTALLATION AND OPERATING GUIDE



*** IMPORTANT ***

**READ INSTRUCTIONS BEFORE INSTALLING THE SYSTEM
TO INSURE PROPER INSTALLATION**

EZ-FLO Connector Required for Installation Sold Separately

- Do not connect to an irrigation system that is not protected by an approved back flow prevention device.
- Do not install if pressure exceeds 100 PSI
- **Use only with non-hazardous products**
- Minimize exposure to direct sunlight to maximize service life
- Protect against freezing to avoid tank fracture

All EZ-FLO systems have been specifically designed and engineered to be installed by a professional irrigation or landscape contractor. Improper installation or use could cause risk of water contamination due to back flow or tank rupture. Failure to follow all safety instructions and warnings could result in serious bodily injury. Improper installation or use of the system voids all warranties.

For additional information or to contact EZ-FLO go to our website
www.ezflofertilizing.com or call **866-393-5601**

TANK ASSEMBLY & PARTS LIST

TANK CAP

Part # CAP- (HPC_{Fine Thread} or HPC_{Coarse Thread})

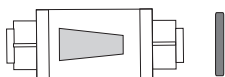
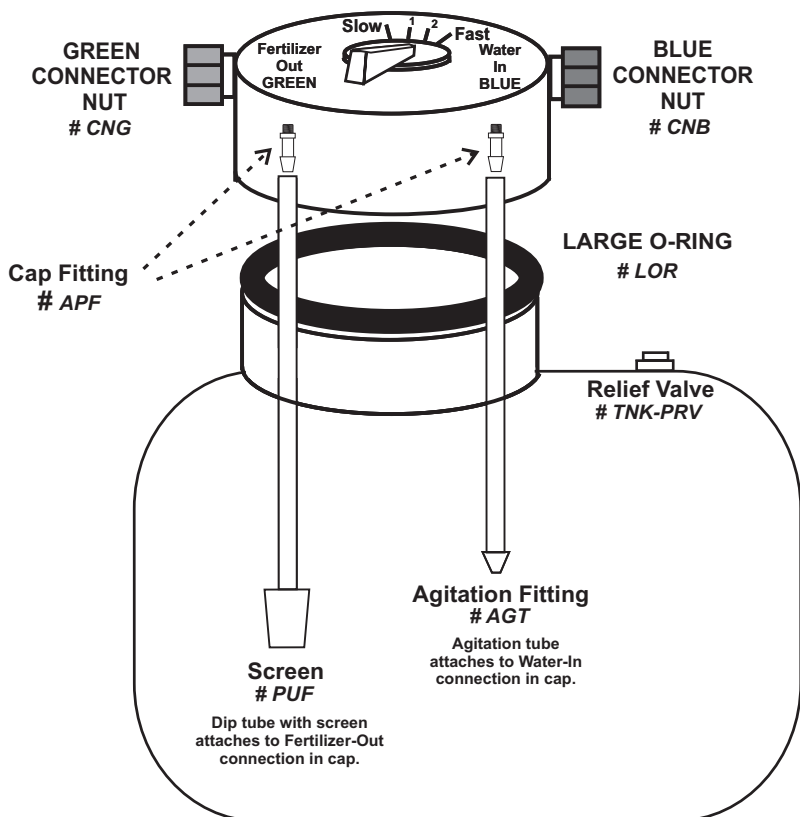

2 - Shut Off Valves
Part # SOV with 2 washers



3 - Tubing Clamps
Part # RTC (1 Extra)

5- Feet 1/4" Black Tubing
Part # BT5

5- Feet 1/4" Clear Tubing
Part # CT5

For EZ-FLO Warranty information visit our website at
www.ezflowfertilizing.com

System Installation

Typical installation

The system is normally installed in a valve box, connected to the main line of the irrigation system after the back flow preventer and before the sprinkler valves. One unit will feed both drip and sprinkler zones without changing any connections or nozzles. It will feed both the front and back yard landscapes.

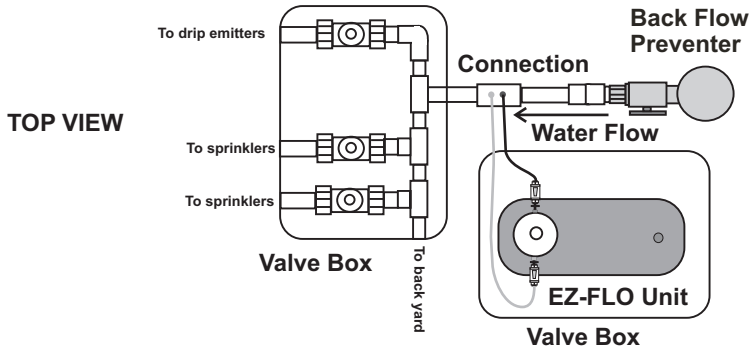

Step 1 - Locate the installation point.

Connection must be made after an approved back flow prevention device. The connection can be made either vertically or horizontally in the irrigation main line. A standard "C" style connection will work for sprinkler systems, a "CBV" style connection is required for low flow, drip, or low pressure connection. EZ005-FX or larger require a "CBV" style connection regardless of system configuration.

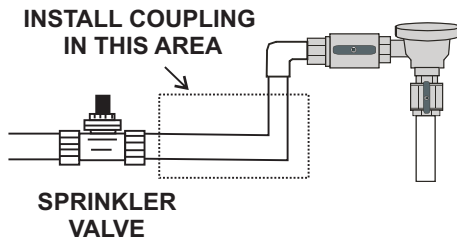

Step 2 - Shut off water and relieve pressure

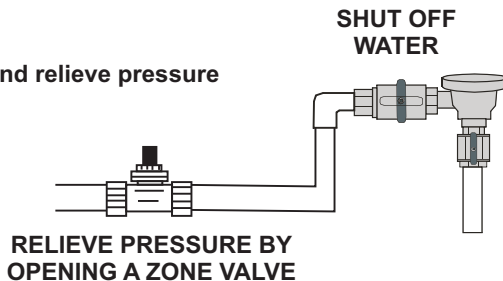

Main Line Connection (Sold separately)

Standard Coupling - 120 gallons per hour minimum flow

Ball Valve Coupling - no minimum (required for low flow or drip irrigation)

Step 3 - Cut out a section of pipe slightly larger than the cut out length of the coupling.

Ball Valve Coupling - Adjustable / Low Flow

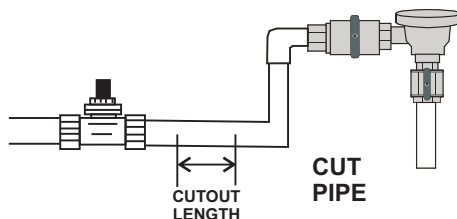
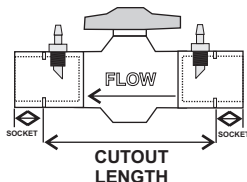

Standard Coupling - High Flow / Sprinkler Only

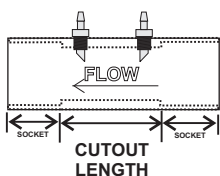

Step 4 - Glue the coupling into the line.

GLUE IN COUPLING
WITH FLOW ARROW
POINTING IN THE DIRECTION
OF THE WATER FLOW

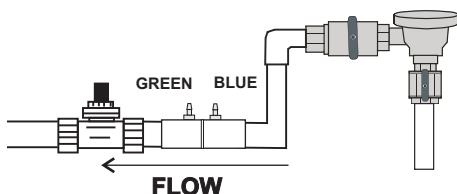

Step 5 - Attach tubing to the coupling.

ATTACH BLACK TUBING TO BLUE
FITTING, CLEAR TUBING TO
GREEN FITTING AND SECURE
WITH TUBING CLAMPS

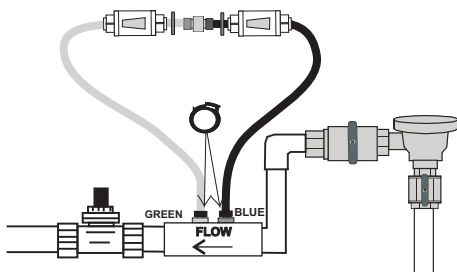

Fill Tank

Step 6 - Fill tank with the recommended amount of product. The EZ-FLO system can be filled with any liquid or water soluble product. Fill the tank based on the product's coverage recommendations.

Fertilizer Typical Coverage Rates:

- Liquid- 1 Gallon per 5,000 sqft every 4 to 6 weeks
- Powder- 1 Pound per 1,000 sqft every 4 to 6 weeks

Pour fertilizer directly into tank and then top off with water until all air is gone from the tank. Allow the water to overflow slightly.

Model	Tank Size	Maximum Capacity
EZ001-CX	1.5 Gallon	10 lbs dry or 1.5 gal. liquid
EZ003-CX	2.5 Gallon	15 lbs dry or 2.5 gal liquid
EZ005-FX	5.0 Gallon	25 lbs dry or 5.0 gal liquid
EZ010-FX	9.4 Gallon	50 lbs dry or 9.4 gal liquid

*** ALL TANK CAPACITIES ARE APPROXIMATE ***

Fill tank with product

Follow all product label precautions. Multiple products can be combined and applied all at one time. Base how much to put in the tank by each product's coverage recommendations.

Do not put weed control in the system

DO NOT LEAVE AIR IN THE TANK!!

Fill with water from shut off valve or back flow preventer until tank overflows.

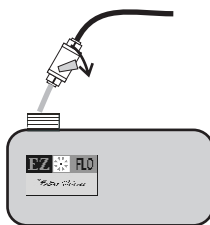
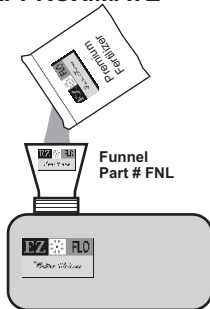

Step 7 - Screw on tank cap

Screw tank cap onto tank

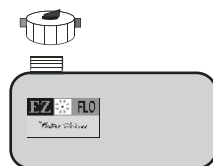

Step 8 - Connect tubing to cap

1. Shut off valves in the off position

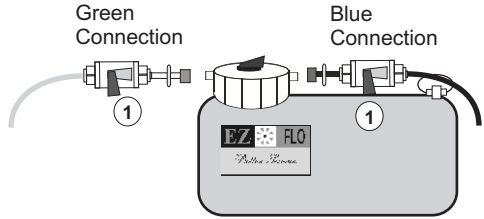

2. Turn water on at back flow preventer

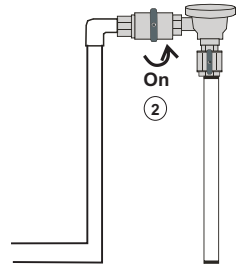

3. Connect blue connector to water in connection on cap. Bleed air from tank by opening the valve slightly on the black line until air is purged

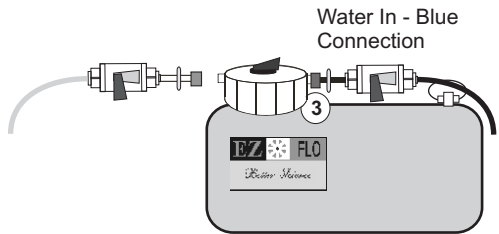

4. Connect green connector to fertilizer out connection on cap and open the shutoff valve.

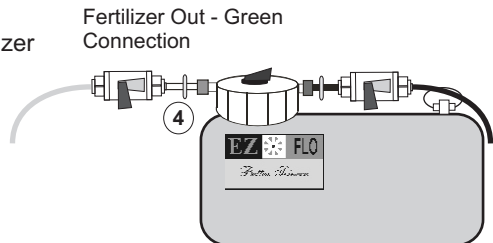

Set Flow Adjustment

Step 9 - Set the flow rate by adjusting the adjustment knob to the proper setting.

Slow Setting - is used for normal maintenance in regions with high watering requirements such as hot dry climates or sandy soils.

#1 Setting - is used for normal maintenance in regions with more moderate climates and moderate watering schedules where soils have good moisture retention.

#2 Setting - is used to encourage fast growth or to quickly improve the condition of a landscape in poor condition. The unit will empty more quickly and can be refilled more often.

Fast Setting - is used to for periodic fertilization. The unit will empty more quickly and can be refilled more often.

Setting	*Ratio	OZ. of fertilizer per gal. of water
Slow	15000:1	.008 (1/20 tsp)
1	8000:1	.017 (1/10 tsp)
2	2000:1	.064 (2/5 tsp)
Fast	400:1	.320 (2 tsp)

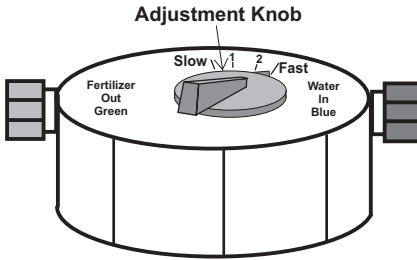

*Ratio refers to the amount of water mixed with the fertilizer. For example, a 400:1 ratio means 400 gallons of water will be mixed with 1 gallon of fertilizer. The adjustment knob can be set in between settings if desired. **These ratios are approximate because feed rates can vary by the type of product being distributed. Ratios are provide as a general guideline only.**

Gallons Of Water Until Empty

The following table shows the approximate gallons of water required to distribute the fertilizer from the EZ-FLO system at the various flow settings.

Model	EZ001-CX	EZ003-CX	EZ005-FX	EZ010-FX
Slow	22,500	37,500	63,500	41,000
1	12,000	20,000	34,000	75,200
2	3,000	5,000	8,500	18,500
Fast	600	1,000	1,700	3,500

EZ-FLO™ FREQUENTLY ASKED QUESTIONS

HOW MUCH PRODUCT SHOULD I PUT IN THE TANK??

For the best results, put in the recommended amount of product for the area being covered, based on the product's coverage recommendations. For example, if the coverage recommendation is 1 pound per 1,000 square feet per month and you are applying the product to 5,000 square feet, put 5 pounds in the tank. If you are combining more than one product in the mix, base the amount of product put in the tank on each product's coverage recommendations.

HOW DO I KNOW WHEN THE TANK IS READY TO REFILL??

Base the refill time on the coverage recommendations of the products put in the system and your desired results. You do not have to refill the system when it is out of product. For example, if the amount of product put in system is based on a monthly coverage, refill every month. You can tell when the system is out of product when there is no color in the clear line when the system is running. If the product you are adding to the tank does not have color add food dye.

WHY DOES WATER COME INTO THE TANK WHEN I TURN ON THE SYSTEM??

You did not properly fill the system, depressurize and remove all air from the system. The tank will always be full of liquid. As the fertilizer is distributed it is replaced with water through a unique & patented layering process.

IF THERE IS ALWAYS WATER COMING INTO THE TANK, DOES THE MIXTURE GET WEAKER AS THE SYSTEM OPERATES??

No. The EZ-FLO patented flow system layers water coming into the tank over the product mix inside the tank. This keeps the product mix in the bottom of the tank. The product mix is pulled from the bottom of the tank to ensure a consistent feed rate. **REMEMBER: The liquid left in the tank may be slightly colored from product coloration, even though the products have been completely distributed.**

CAN I USE PESTICIDES AND HERBICIDES IN THE SYSTEM??

The system can distribute virtually any liquid or water soluble product but caution must be used so products are not applied improperly. Read the instructions carefully on any product used to ensure they are applied properly and are compatible with other products in the mix. Hazardous products are not recommended for use in the EZ-FLO system.

IF I FERTILIZE EVERY TIME I WATER, WON'T I OVER FERTILIZE??

No. When the unit is set on the maintenance (slow) setting it feeds in small bite size amounts. It applies less fertilizer over the same period of time than applying in large amounts once every 6 weeks. Studies have shown that when plants are fed continually, in small amounts, they are healthier and more insect and disease resistant and require 70% to 80% less fertilizer.

HOW CAN PLANTS BE HEALTHIER WITH LESS FERTILIZER??

When fertilizer is applied in large amounts periodically, it cannot be absorbed efficiently by the plants. Studies have shown that this absorption rate can be as little as 10%. **When fertilizer is applied the EZ-FLO way, up to 100% of the nutrients are absorbed by the plants.**

WILL THE SYSTEM CLOG DRIP SYSTEMS??

No. Actually many of the products that are applied through the system can help keep drip systems clean by reducing calcium deposits that clog drip systems. Products can be put in the system to clean drip systems.

HOW DO I WINTERIZE THE SYSTEM??

Simply close the shut off valves, disconnect it from the irrigation system and drain the tank.