

# 12-Outlet Maverick Drip Head

## Installation and Operating Instructions

### Features

- 12-Outlet drip irrigation head
- 1/2 in. FNPT thread
- 12 individually pressure compensating emitters
- Working pressure from 8-80 PSI
- Recommended working pressure 15-50 PSI
- May be used with 1/8 in. or 1/4 in. micro tubing
- Removeable emitters to combine drippers with micro sprinklers in a single head
- Color coded emitters and barbs to easily identify flow rate at each outlet
- Available flow rates and model numbers:
  - PC 1201 – 1 GPH
  - PC 1202 – 2 GPH
  - PC 1204 – 4 GPH
  - PC12100 – Kit assembly with 2 GPH emitters
  - PC14100 – Kit assembly with 4 GPH emitters
- Each nozzle individually filtered
- Internal Mini-Disk filter



## INTRODUCTION

Thank you for purchasing the DIG 12-Outlet Maverick Drip Head. Please take the time to read through the enclosed instructions and follow them step by step. If you have any questions, please call our customer service line 1-800-322-9146.

## 1. 12-OUTLET MAVERICK HEAD

DIG 12-Outlet Maverick drip irrigation heads are designed to be adapted to any 1/2 in. riser, above or below ground. They may be incorporated into a new system, or used to convert existing sprinkler risers into 12-Outlet drip systems. Available with our extremely accurate pressure compensating emitters in three flow rates PC1201 – 1 GPH, PC1202 – 2 GPH, PC1204 – 4 GPH per outlet. 12-Outlet Maverick heads may be used with either DIG 1/8 in. or DIG 1/4 in. micro tubing.

## 2. HOW TO INSTALL

1. If converting an existing sprinkler system to a Maverick head, first remove the sprinkler. Then turn on the water to flush the line.

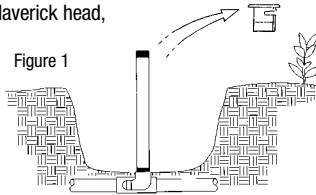

Figure 1

2. After the line has been flushed, thread the Maverick onto the riser.

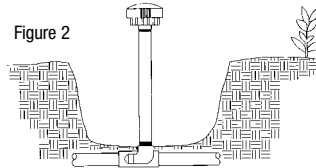

Figure 2

3. Excavate a narrow path to a depth of 4 in. from each individual plant to the Maverick and lay out micro tubing within the trenches or leave micro tubing above ground and cover with mulch.

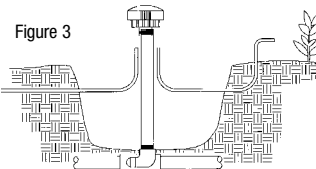

Figure 3

4. Remove the cover and the Mini-Disk filter. Attach 1/8 in. micro tubing to the outlet side (see Figure 4). If using 1/4 in. micro tubing, first connect a 1/4 in. converter barb onto the 1/4 in. micro tubing (see Figure 5) and then insert the converter barb into the outlet side of the Maverick.

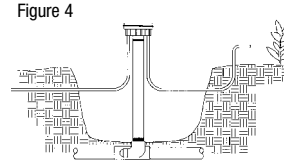

Figure 4

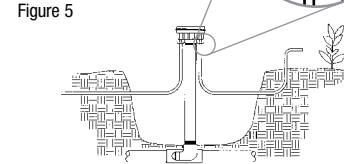

Figure 5

5. Use the rubber caps provided to close all unused outlets. Do this by removing the cover and the Mini-Disk filter. Press the rubber caps into the unused outlets. Re-install the Mini-Disk filter and cover. Tighten cover by hand.

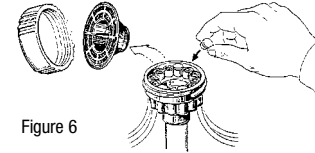

Figure 6

6. Secure micro tubing near plants. If using more than one outlet per plant, space each outlet a minimum of 6-8 in. apart. Attach the plastic stake to end of the micro tubing and add a bug plug at the end of micro tubing. A bug plug prevents insects from crawling into the tubing, which they sometimes do to lay their eggs. The bug plug will still allow water to trickle out for the plants.

**NOTE:** Bug plugs may be used only with 1/8 in. micro tubing. (see Figure 7)

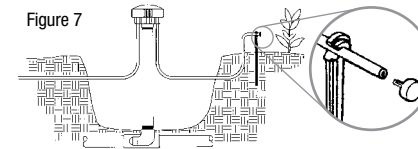

Figure 7

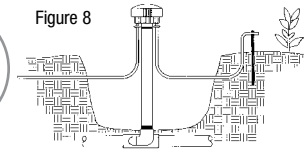

Figure 8

7. Backfill all trenches.

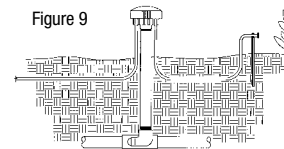

Figure 9

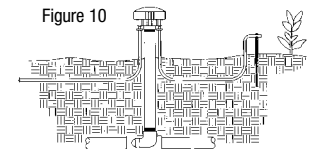

Figure 10

8. Pressurize the system and verify that the 12-outlet head is properly functioning and if needed, make any necessary corrections.

When designing a system, we recommend that the maximum length of micro tubing from each outlet should not exceed 8-10 ft.. Longer lengths may certainly be achieved, but please consider the factor of maintenance and aesthetics.

### 3. 12-OUTLET ACCESSORIES

The standard micro tubing to be used with the 12-Outlet Maverick is 1/8 in. flexible vinyl with a wall thickness of .118 ID x .187 OD. With the addition of a 1/4 in. converter barb or elbow, vinyl 1/4 in. micro tubing can be used.

Model #	B34	1/8 in. 50 ft. micro tubing .118 ID x .187 OD black vinyl
	B38	1/4 in. 50 ft. micro tubing .156 ID x .245 OD brown vinyl
	B38100	1/4 in. 100 ft. micro tubing .156 ID x .245 OD black vinyl
	B38500	1/4 in. 500 ft. micro tubing .156 ID x .245 OD black vinyl

#### BUG CAP

Bug caps should be inserted at the end of each 1/8 in. micro tubing outlet, if used with any #57 or #58 stake, permitting free flow of water with minimum restriction from the outlet. This also secures the system against bugs and dirt from restricting the flow and contaminating the outlet port.

12 Bug plugs for 1/8 in. micro tubing (special order only) Model 10-016

#### 1/4 IN. BARB OR ELBOW CONVERTER

1/4 in. converter barb or elbow is only necessary if 1/4 in. micro tubing is used. The converter has a compression side to be inserted into the drip head body. The other side is a 1/4 in. barb to 1/4 in. micro tubing.

Converter barb is color coded to signify which emitter is installed

Model #	10-012	Red converter barb to be used with 1/4 in. micro tubing
	10-013	Green converter barb to be used with 1/4 in. micro tubing
	10-014	Purple converter barb to be used with 1/4 in. micro tubing
	10-017	Black converter barb to be used with 1/4 in. micro tubing
	25-007	Black converter elbow to be used with 1/4 in. micro tubing

### 4. CONNECTING MICRO SPRINKLERS

The Maverick head can be used with micro sprinklers by following these steps:

1. Remove cover and the disc filter
2. Remove emitter from the outlet to be used with the micro sprinkler by using a small screwdriver
3. Convert the outlet using a 1/4 in. converter barb
4. Attach a 1/4 in. micro tubing to the converter barb
5. Connect 1-2 micro sprinklers per outlet

Make sure not to exceed 25 GPH and 50 ft. of 1/4 in. micro tubing

### 5. RECOMMENDED NUMBER OF OUTLETS PER PLANT

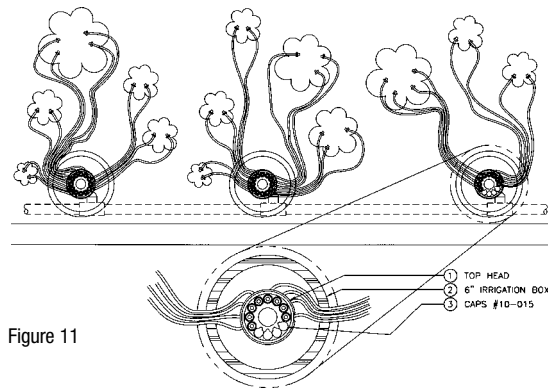

Figure 11

### 6. ABOVE OR BELOW GROUND INSTALLATION

Using 1/8" Micro tubing

Above Ground

Below Ground

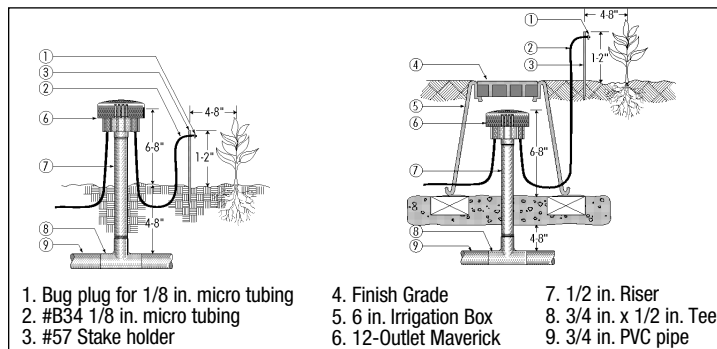

1. Bug plug for 1/8 in. micro tubing
2. #B34 1/8 in. micro tubing
3. #57 Stake holder

4. Finish Grade
5. 6 in. Irrigation Box
6. 12-Outlet Maverick
7. 1/2 in. Riser
8. 3/4 in. x 1/2 in. Tee
9. 3/4 in. PVC pipe

## 7. TO ORDER PARTS

We at DIG Corporation understand that most stores do not carry spare parts. For your convenience, if you need one of these parts, please visit [www.digcorp.com/rparts](http://www.digcorp.com/rparts). Parts will be sent within 7 days.

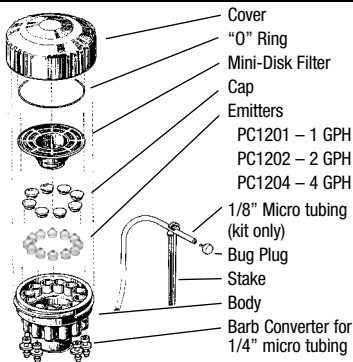

## DIG CORPORATION 2 YEAR LIMITED WARRANTY

DIG CORPORATION warrants these products to be free from defects in material and workmanship for a period of two years from date of purchase. This warranty does not cover damage resulting from accident, misuse, neglect, modification, improper installation or subjecting to line pressure in excess of 150 lbs. per square inch. This warranty shall extend only to the original purchaser of the product for use by the purchaser. The obligation of DIG CORPORATION under this warranty is limited to repairing or replacing at its factory this product which shall be returned to the factory within one year after the original purchase and which on examination is found to contain defects in material and workmanship.

DIG CORPORATION SHALL IN NO EVENT BE LIABLE FOR ANY INCIDENTAL OR CONSEQUENTIAL DAMAGES OF ANY KIND; THE SOLE OBLIGATION OF DIG BEING LIMITED TO REPAIR OR REPLACEMENT OF DEFECTIVE PRODUCTS. SOME STATES DO NOT ALLOW THE EXCLUSION OR LIMITATION OF INCIDENTAL OR CONSEQUENTIAL DAMAGES, SO THE ABOVE LIMITATION OR EXCLUSION MAY NOT APPLY TO YOU.

Unattended use for prolonged periods without inspection to verify proper operation is beyond the intended use of this product, and any damage resulting from such use shall not be the responsibility of DIG CORPORATION. There are no warranties which extend beyond the description on the face hereof. In the case of purchase of the product for use other than, for irrigation purposes, DIG CORPORATION hereby disclaims any implied warranties including any warranties of merchantability and fitness for a particular purpose. In the case of the purchase of the product for personal, family or household purposes, DIG CORPORATION disclaims any such warranties to the extent permitted by law. To the extent that any such disclaimer or implied warranties shall be ineffectual, then any implied warranties shall be limited in duration to a period of one year from the date of the original purchase for use by the purchaser. Some states do not allow limitation on how long an implied warranty lasts, so the above limitation may not apply to you.

In order to obtain performance under this warranty, the unit must be returned to the factory, along with proof of purchase indicating original date of purchase, shipping prepaid, addressed as follows:

DIG CORPORATION, 1210 Activity Drive, Vista, CA 92081. Repaired or replaced units will be shipped prepaid to the name and address supplied with the unit returned under warranty. Allow four weeks for repairs and shipping time. Repair of damaged units not otherwise within warranty may be refused or done at a reasonable cost or charge at the option of DIG CORPORATION.

This warranty gives you specific legal rights, and you may also have other rights which vary from state to state.

## CUSTOMER SERVICE:

1-800-322-9146 FAX: 760-727-0282



1210 Activity Drive • Vista, CA 92081-8510, USA

Website:

[www.digcorp.com](http://www.digcorp.com)

e-mail: [dig@digcorp.com](mailto:dig@digcorp.com)

020509 DIG CORP 26-001

Printed in the USA

DIG is a Registered Service Mark of DIG Corp.

