

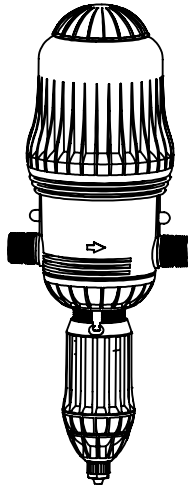

---

# MixRite 3

**Proportional Injector**



**USER MANUAL**

---

[www.demaeng.com](http://www.demaeng.com) E-mail: [sales@demaeng.com](mailto:sales@demaeng.com)





## User Manual

The **MixRite** is powered by water flow, with minimal loss of pressure. The water engine powers the proportioning unit. No external power is required.

The proportioning unit injects liquid additives in direct relation to the amount of water that passes through the motor and injects the additives into the water system.

### The water engine action:

The suction and proportioning unit is built from a piston connected to the water engine, from which it derives its movement. The piston moves within a cylinder with a non-return valve. The movement of the piston within the cylinder causes the water to be injected and the required liquid additive to be drawn through a pipe inserted into a container. It is possible to regulate the supply ratio between the additive and the water passing through the injector.

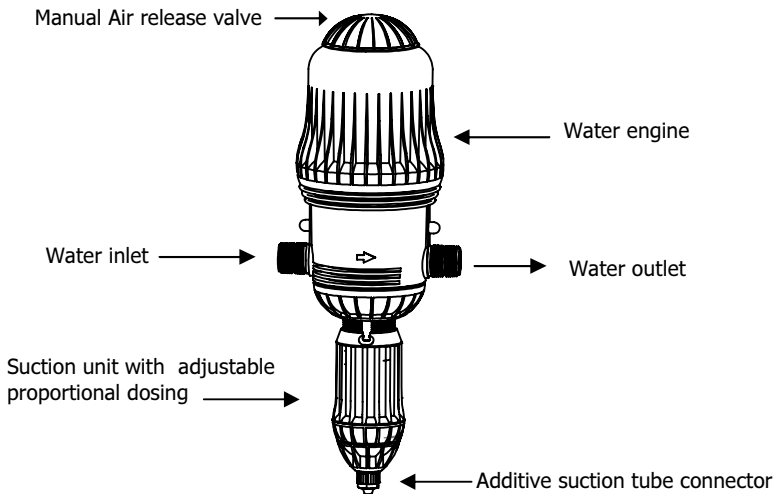



## Technical Data

The MixRite operates in the following conditions:

- From a minimum flow rate of 20 L/H (0.088 GPM) and up to 3,175 L/H (14 GPM) ,subject to the model.
- Temperature not lower than 4°C (39°F) and not higher than 40°C (104°F)
- Water pressure between 0.2 Bar to 8 Bar (2.9 to 120 PSI)

The additive may be added to the water flow according to the required dosing percentage:

0.03% to 0.2%

0.1% to 0.9%

0.3% to 2%

1% to 5%

1 % to 10%

Water pressure loss:

Pressure loss ranges from 0.1 Bar ( 1.5 PSI) in the lower flow rates to 1.8 Bar (26.5 PSI) in the higher flow rates.

- \* Models with 0.03%-0.2%: from 0.1 Bar up to 1 Bar in proportion to the water flow ( 1.5 - 15 PSI).
- \* Models with 0.1%-0.9%: from 0.1 Bar up to 1 Bar in proportion to the water flow ( 1.5 - 15 PSI).
- \* Models with 0.3%-2%: from 0.1 Bar up to 1 Bar in proportion to the water flow ( 1.5- 15 PSI).
- \* Models with 1%-5%: from 0.2 Bar up to 1.2 Bar in proportion to the water flow ( 3- 17.5 PSI).
- \* Models with 1%-10%: from 0.5 Bar up to 1.8 Bar in proportion to the water flow ( 7.5- 26.5 PSI).

The MixRite inlet and outlet are ¾" BSPT male thread.

The additive tank should be placed beneath the MixRite.

### Mounting the MixRite

1. Preparing the MixRite site.
  - To connect the MixRite inlet and outlet must reach the inlet and outlet pipes.
  - The MixRite must be positioned above the liquid additives container.
2. Screw the MixRite bracket onto a wall or any stable vertical base.
3. Press the MixRite onto the bracket.  
The nipples on the MixRite must click into the holes in the side of the bracket.

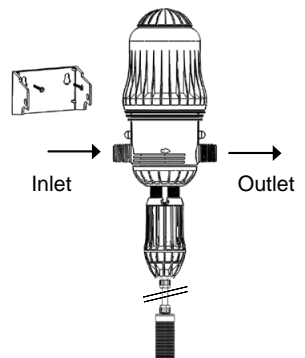



## Installation of the MixRite

### Installing the MixRite on a Direct Line (in line)

1. Install onto the water line using swivel connectors and ensure that the water flows into the MixRite in the direction indicated by the arrows printed on the MixRite.
2. Install a 120 mesh (130 micron) filter between the valve and the injector inlet.
3. Valves have to be installed at the water line entry and exit; in order to stop the pump's action – you should close the Valve at the entry point.
4. Position the drawing pipe into the additive container. Ensure that the suction pipe filter is set 1/2" above the container's bottom. Check to ensure that the suction pipe is not bent or folded.

### Install the MixRite on a Direct Line (In Line)

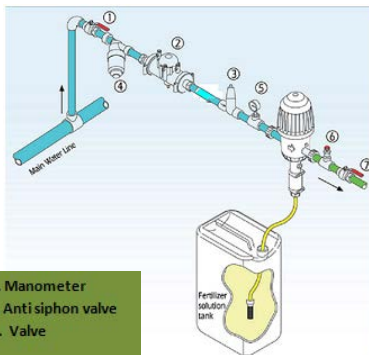

### Correct Installation

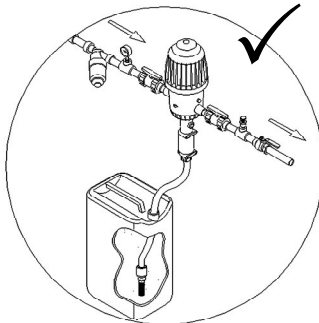

### Incorrect Installation

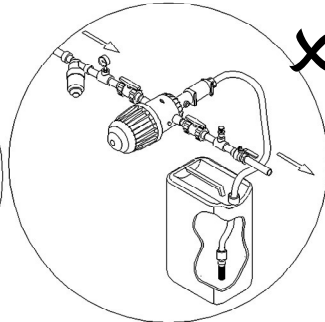



### Installing the MixRite on a Bypass line (off line)

Where water is supplied at a higher flow rate, than the working flow rate of the injector or where the injector isn't needed for continuous operation, the MixRite should be installed on a bypass line. The bypass provides the possibility to close the operation of the injector while water continues to flow through the line.

1. Install onto the bypass water line using swivel connectors and ensure that the water flows into the MixRite in the direction indicated by the arrows printed on the MixRite.
2. Install a 120 mesh (130 micron) filter between the valve and the injector intake.
3. Valves have to be installed at the bypass entry and exit and on the main water line.
4. Position the liquid additive container beneath the injector. Check to ensure that the suction pipe is not bent or folded. Position the drawing pipe into the additive container. Ensure that the suction pipe filter is set 1/2" above the container's bottom.

### Install the MixRite on Bypass Line (Off Line)

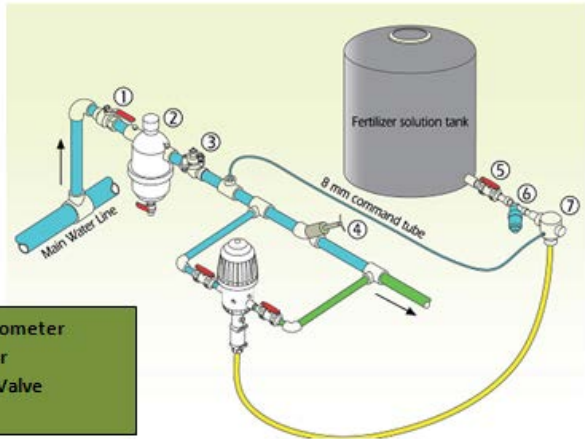

- |                            |              |
|----------------------------|--------------|
| 1. Main valve              | 5. Manometer |
| 2. Filter                  | 6. Filter    |
| 3. Pressure reducing valve | 7. NC Valve  |
| 4. Choking valve           |              |



**A MixRite Bypass installation**  
**3.0 (M/h)14 GPM**  
including mobile fertilizer solution  
tank

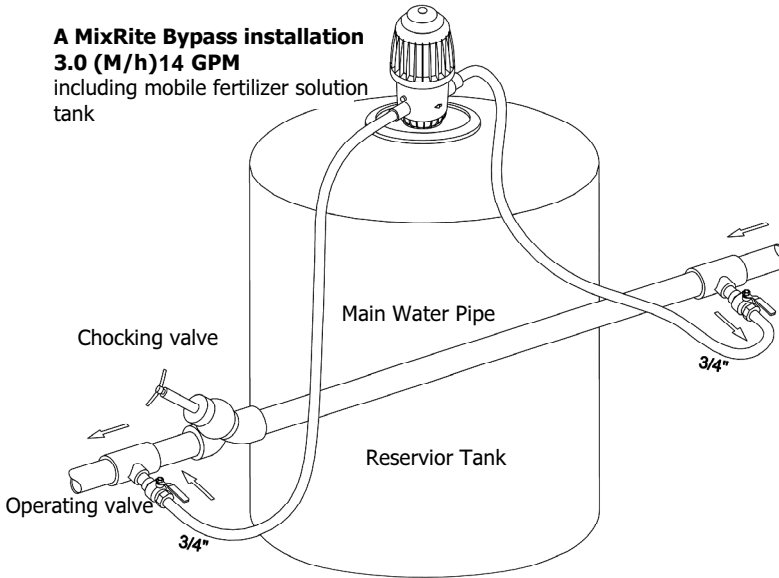

**Adjusting the MixRite**

Every stroke of the MixRite moves a predetermined volume of water with a predetermined volume of liquid additive.

To adjust the volume of the liquid additive in models 0.03%-0.2%, 0.1%-0.9%, 0.3%-2% , 1%-5%,1%-10% :

1. Preset the amount of additives according to the Percentage or ratio to water Scale that is found on the proportioner.
- Turn the proportioning Adjuster counter clock-wise to increase the amount of additives.
- Turn the Proportioning Adjuster clock-wise to decrease the amount of additives.

The marking on the scale indicates the Percentage or ratio of additive out of the total water flowing through the injector.

2. Ensure to lock the Latch nut after adjusting.

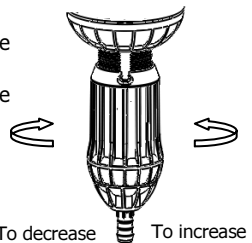



## Rinsing and Cleaning the unit

After using the injector -

- Rinse the unit by drawing clean water from the additive container.
- Wash the external surface of the unit with clean water.

**Warning: During injecting, ensure that the additive container is not completely empty.**

## Air-release Valve

In models supplied with Air-release valve.

After initial operation of the MixRite, apply pressure to the cap (the air release valve) for several seconds to open the valve. This allows trapped air to escape. This air release is accompanied by a slight loss of water. Release the pressure on the cap to close the valve.

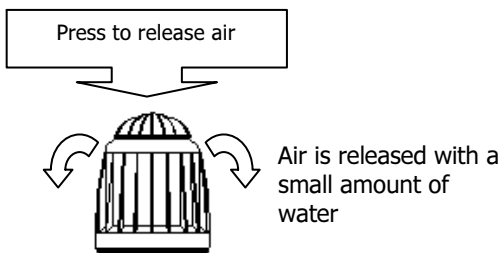

NOTE : The time required to prime the suction tube depends on the water flow-rate , the percentage or ratio set and the length of the suction tube.To bleed the air from the suction tube and accelerating the priming ,set the injection rate at the Maximum .Once the MixRite suction tube is primed ,adjust to the required injection rate





## On/Off System

In Models supplied with On/Off System :

**ON** position – the Knob should be in its high position, the injector is working & drawing additive.

**OFF** position – The knob is pushed down and turned.

The water flow to the injector continues without the pumping action. To Turn the dosage unit off and allow the free flow of water through the **MixRite**:

A: The handle must be turned and pushed in so that it is in the close position.(see 1).

To turn the dosage unit on and allow the pumping action **MixRite**:

B: The handle must be turned and pulled out so that it is in the opened position.(see 2).

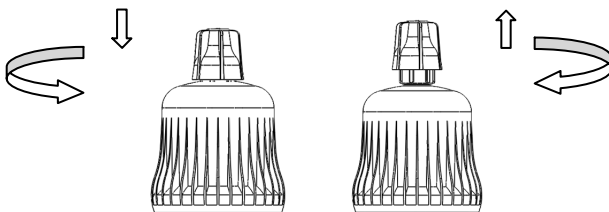

Diagram 1

Diagram 2

In injectors with On/Off knob there is no air-release valve.

It is highly recommended to use the On/Off knob when the additive container is empty or there is no need at all to inject the additive but the water flow should continue.



## Troubleshooting

Problem	Check	Solution
MixRite does not operate	Check that the inlet and outlet valves are open	Open the valve
	Check that the water filter isn't clogged	Clean the filter
	Check that water is flowing in the line	Open main and outlet valve
	Check that springs are not broken Open pump lid & remove piston	Change the broken spring
	Check that cylinder is not scratched	Change cylinder
	Check that piston seals are not damaged	Change the seals
MixRite does not draw	Dismantle the suction pump and check the suction seal for damage	Change the suction seal
The MixRite makes scratching noises	Check if there is liquid in the additive container	Add liquid to the container
	Check if suction pipe is immersed and not folded	Straighten or change the pipe
	Check suction filter to see if it is blocked and if it is immersed in the additive tank	Clean and rinse suction filter, Fill liquid into tank to cover filter









### Correct installation will prevent damages and malfunctions of the MixRite

It is strongly recommended to install a back flow preventor before the injector on the main water line.

A vacuum release unit should be installed at the outlet of the MixRite in order to prevent undesired suction of additive when the water line is draining.

A master valve must be installed before the injector, to be opened only at the operation of the injector to prevent water hammer damage to the injector.



<u>Models</u>	<u>On/Off</u>	<u>Air release</u>	
1400A 1400M	0.03 - 0.2%		
1401A 1401M	0.1 - .09%		
1402A 1402M	0.3 - 2%		
14.CW.05	1 - 5%		
1410A 1410M	1 - 10%	